



INFINITY

600 EL

OWNER MANUAL

**INCLUDES
USER INSTRUCTION
&
INSTALLATION & MAINTENANCE
INSTRUCTIONS**

**Please read these instructions carefully before you start installing or using this
appliance**

Keep this booklet handy for future reference

**This appliance is
for use in Great Britain or
IRELAND only**

INFINITY

Charlton & Jenrick LTD
Telford
Shropshire
TF3 3AR

CONTENTS**PAGE****USERS INSTRUCTIONS****SECTION ONE Introduction**

Consumer Protection Information.....	3
Health & Safety Notice.....	3
Introduction.....	3
Important Information.....	4

SECTION TWO Operating Appliance

Lighting the Appliance.....	5
Replacing Hand Set Battery.....	6
Replacing Appliance Battery.....	7

SECTION THREE Cleaning

Cleaning Pilot Assembly.....	8
Cleaning Glass panel.....	8
Removing Glass Panel.....	9

SECTION FOUR Fuel Bed Cleaning & Layout

Cleaning Fuel Bed.....	9
Log Fuel Bed Layout.....	10

SECTION FIVE General Points

12

INSTALLATION INSTRUCTIONS**SECTION SIX Appliance Data**

13

SECTION SEVEN Regulations and Warnings

14

SECTION EIGHT Siting the Appliance

Flue (Class1).....	15
--------------------	----

SECTION NINE To Install Appliance

Checking the Flue and Fire Opening.....	17
Gas Supply Routing.....	17

SECTION TEN Checking Fire Operation

Check Gas soundness.....	18
Checking Product Clearance.....	19
Advice To Customer.....	19

MAINTENANCE INSTRUCTIONS**SECTION ELEVEN Maintenance**

General.....	20
Pilot Linting.....	20
To remove the burner tray.....	20
Replacement of gas control.....	20
Replacement of injectors.....	20
Replacement of Oxy-pilot assembly.....	21
Replacement of Control Unit (EDB).....	21

SECTION TWELVE Wiring Diagram

21

SECTION ONE Introduction

Consumer Protection Information

As manufacturers and suppliers of heating products, we take every care, as far as is reasonably practicable, that these products are so designed and constructed as to meet the general safety requirement when properly used and installed. To this end, our products are thoroughly tested and examined before despatch.

IMPORTANT NOTICE: Any alteration that is not approved by the appliance manufacturer could invalidate the approval of the appliance, operation of the warranty and could affect your statutory rights.

Health and Safety Notice

Important

This appliance could contain some of the materials, indicated below, that could be interpreted as being injurious to health and safety. It is the users / installers responsibility to ensure that the necessary personal protective clothing is worn when handling these materials, see below for information.

Artificial Fuels, Mineral Wool, Insulation Material, Refractory/Ceramic Fibres, Glass Yarn - may be harmful if inhaled, may be irritating to skin, eyes, nose and throat.

When handling *avoid inhaling and contact with skin or eyes. Use disposable gloves, facemasks and eye protection. After handling wash hands and other exposed parts. If a vacuum is used for cleaning the coals or cleaning after servicing / installation it is recommended that it be of the type fitted with a HEPA filter.*

Disposal of refractory/ceramic materials. To keep dust to a minimum these materials should be securely wrapped in polythene and be clearly labelled 'RCF waste'. These materials are not classified as 'hazardous waste and should be disposed of at a site licensed for the disposal of industrial waste.

INTRODUCTION

- The 600 FL as been designed and tested to the requirements of EN 613 and is suitable for use in GB (Great Britain) and IE (Ireland).
- The 600 FL incorporates a single gas control, which selects ignition pilot, with variable setting between low and high settings and is operated via remote control. The system is powered by a battery pack; therefore no mains electrical supply is required.
- Like all appliances incorporating an aerated burner a low frequency noise may be heard, this may be more noticeable on the low setting.
- The 600 FL incorporates a safety device in the form of an Oxygen Depletion System, which constantly monitors the oxygen in the room and will cause the fire to switch off if the oxygen level reduces, for instance due to insufficient ventilation or a blocked flue.
If this regularly occurs do not attempt to relight the appliance until a qualified engineer has checked it, the problem may not be due to lack of air or a defective flue.
- The pilot can be left on (standby setting) or the pilot can be extinguished and relit each time the fire is used.

SECTION ONE Introduction Continued

The 600 FL is battery operated; therefore no mains electrical supply is required. Power to the appliance is provided by 6 high power alkaline 1.5V batteries (C size) (a spare set of 6 C batteries is supplied with the appliance).

If you hear a repeated 'bleep' sound come from the appliance this indicates the appliance battery pack is low and should be changed. If this is ignored the system will go into a lock out mode, which will not allow the appliance to be use until a new set of batteries are loaded. (See Page 6)

IMPORTANT INFORMATION

- The appliance is for use on Natural Gas (G20 @ 20mbar or G21 @ 37mbar) only.
- The chimney or flue (unless new or previously used with a gas appliance) shall be swept before installation if it has been used for solid fuel.
- Failure to install appliance correctly could lead to prosecution.
In GB (Great Britain), the appliance must be installed by a competent person i.e. GAS SAFE-registered, in accordance with the GAS SAFETY (INSTALLATION AND USE) REGULATIONS, The Building Regulations (or The Building Regulations (Scotland) or The Building Regulations (Northern Ireland)) and The Current I.E.E. Wiring Regulations, if appropriate.
In IE (Ireland), the appliance must be installed by a competent person and installed in accordance with the current edition of I.S.813 Domestic Gas Installation, the current Building Regulations and the current ETCI rules for electrical installation, if appropriate.
- The glass front of this fire acts as a dress guard, conforming to BS 1945 (1997) however; a fireguard conforming to BS6539 (1997) must be used to protect young children, the elderly or infirm.
- The appliance **MUST NOT** be used with the glass safety screen removed or if it is damaged or cracked.
- During initial firing, an odour may be evident. This is the starch binder used during the manufacture of the fibre components of the fire, and there are **no harmful** effects produced.
- During the normal operation of the fire some black staining may appear on some parts of the fuel bed. This is quite normal and adds to the appearance of the appliance. However, if excessive black staining does occur it may be due to the fuel bed being incorrectly laid. This should be checked prior to contacting a service engineer.
- When using black glass liners care should be taken to ensure flames do not make contact with them as this will result in staining or permanent marking.



600 FL Users Instructions

SECTION ONE Introduction Continued





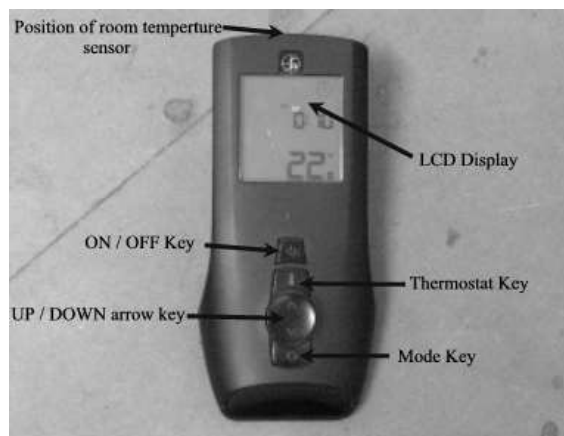

- Care must be taken to prevent any damage being caused to surrounding soft furnishing or decoration; e.g. many embossed vinyl wall coverings may become discoloured if placed too close to the appliance. Combustible material i.e. wall panelling or wallpaper must be removed from behind the fire and fire trim.
- It is advised that this appliance is serviced annually as recommended by Gas Safe. This is more likely to provide trouble-free operation and is a requirement of the extended parts warranty.(see page 20)
- In GB (Great Britain) the fire does not normally require purpose built ventilation, but if for any special reason purpose built ventilation is provided it should be checked periodically to ensure freedom from obstructions.
- In IE (Ireland) permanent ventilation must comply with the current edition of IS813.

SECTION TWO Operating the Appliance

To light the appliance using the remote hand set:

- a. Press the  button. Continue to hold the button for approximately 2 seconds and release. When released a bleep should be heard and the appliance will automatically go through the ignition sequence and the pilot should ignite. Once the pilot is alight the appliance will automatically go to the high setting (approximately 20-25sec).
- b. If the ignitor stops sparking and the pilot has failed to light press the  button for at least 2 seconds and release again a bleep should be heard. Then repeat the lighting procedure.* **see note on page 7**



- a. With the appliance lit, by pressing  key the operational mode is switched from manual to Room Thermostat setting and vice versa. When Room Thermostat mode is active, the display shows the set temperature value and the “AUTO” icon will appear on the LCD display. By using the  arrow key the desired room temperature can be set. When manual mode is active, the display shows the “MAN” icon plus the flame icon and a five level bar icon setting. By pressing the  arrow key, the flame picture can be adjusted at five stages between high and low flame. If level 5 is currently active, the icon max  below the flame icon will appear. ***Note: Due to the nature of the gas, flame variation on LPG models will only be visible on Hi and Lo setting***
- b. To switch off the appliance press the  button for at least 2 seconds and on releasing the button the appliance will bleep and then shut off. For pilot setting press the  button for 1 second and release. The pilot symbol will appear on the LCD display. Pressing the  will bring the fire back on to main flame.
- c. The appliance can be switch off with out using the hand set by removing the appliance batteries located below the air grill cover. When the batteries are removed there will be a delay (up 3minutes) after which double bleeps may be heard and shortly after the appliance will extinguish. Ensure that the battery is reconnected once the fire as been extinguished. The appliance cannot be operated without the use of the handset.

Room Thermostat mode

The remote handset checks the room temperature at a fixed time intervals. Depending on the difference between set room temperature and the actual room temperature the remote proceeds to modulate in one level steps. Once the room temperature is reached it moves to standby position pilot only. The icon “PILOT” will appear on the LCD display. As soon as the actual room temperature falls

SECTION TWO Operating the Appliance Continued

below the SET room temperature, the system will move from standby to the high flame level. From this point it will proceed again the modulation process.

Note: Due to the temperature checks at timed intervals, the display temperature on the handset may exceed the room setting temperature before the appliance defaults to the pilot setting.

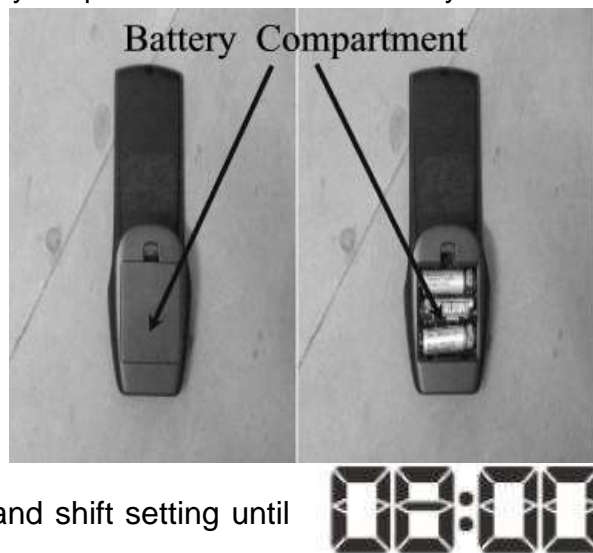

TO REPLACE BATTERY IN HAND SET (3 AAA TYPE BATTERIES)

Remove the cover from the rear of the handset and fit replacement battery.



Clock Regulation

As soon as the batteries are fitted the timer digits will

blink. Using the  arrow key increase or decrease the hour, minutes and week's value. Pressing the  will set and shift setting until complete.

Note: This time setting is for guidance only and does not have a guaranteed accuracy level.

Changing Clock Setting During Operation

To amend clock setting press both the  and  keys simultaneously for three seconds, the written clock will appear. To change the clock settings, repeat the above described operation.

Change From Celsius to Fahrenheit





With remote OFF, keeping pressed  key at least for 5 seconds, the temperature unit changes from Celsius to Fahrenheit degrees and vice versa.

Battery level indication (Handset)





When the batteries have to be changed in the handset, the related icon will appear.

Setting the sleep mode

To activate the sleep mode: With the fire switched on press the  button. The sleep symbol will appear top right . The sleep symbol replaces the time indicator in this mode. Using the  arrow key increase the sleep mode in 15 minute intervals (a small star will be visible next to the sleep symbol once any time is set) . Once the set time is reached, the fire will completely switch off without any further intervention.

When the fire is next operated, the sleep mode will automatically appear unless it is re-set to zero.

This can be done by pressing the  key and using the  button to decrease the time set by 15 minute intervals until back to zero.

If you experience unexplained outing on the fire please check that the sleep mode is switched off.

SECTION TWO Operating the Appliance Continued

Child Lock (Handset)

To activate `Child Lock` : Press and hold the Mode Key **O** button for 5 seconds, this will lock and disable the handset and a “padlock” symbol will appear on the bottom of the screen. This can be done while the fire is “off” or “on”. To deactivate this function press and hold the Mode Key **O** for 5 seconds and the “padlock” symbol will disappear.

LOW BATTERY INDICATION (APPLIANCE)

If you hear a repeated ‘bleep’ sound come from the appliance this indicates the appliance battery pack is low and should be changed. If this is ignored the system will go into a lock out mode, which will not allow the appliance to be use until a new set of batteries are loaded.

NOTE: The appliance cannot be used when the battery is completely discharged.

TO REPLACE APPLIANCE BATTERIES (6 High Power Alkaline C 1.5V)

- a. Remove the fireplace frame covers which are held in place with magnets.
- b. Lift out the air grill cover from the bottom of the frame assembly.
- c. The battery power pack holder is located in a compartment at the left hand side of the burner. Carefully lift the battery holder out of the compartment and replace the six high power alkaline C batteries as a complete set. **WARNING, batteries will overheat if fitted incorrectly, when fitting the batteries ensure that they are fitted as per the marking on the rear of the holder (i.e. minus of battery against spring).**
- e. Once the new batteries are loaded the fire will continue to bleep until re-set. Press the ON / OFF key for at least 2 seconds, on release a bleep sound be heard and the ignition process will start. If the fire continues to bleep this may indicate a loose connection or badly loaded batteries.

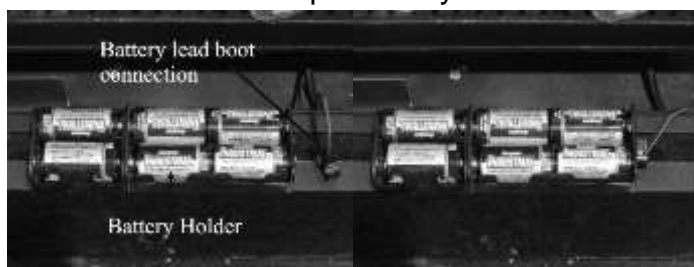

***Important :** If the fire burner or pilot is extinguished for any reason, do not attempt to re-light the pilot for at least 3 minutes.

600 FL Users Instructions

SECTION THREE Cleaning

Warning: -

Before you clean any part of the appliance ensure that the appliance is turned off and cold.

CLEANING: PILOT ASSEMBLY

(Before cleaning ensure that the appliance is turned off and cold)

In some instances you may experience ignition problems even when the appliance is new. This may be due to the aeration hole in the pilot body being partial blocked with dust, pet hairs, or other foreign matter. The source of this debris could be such things as carpet fibres, decorating or pet etc.

To gain access to the pilot please do the following.

- Remove the two side covers LH and RH.
- Undo the two M4 nuts retaining the glass fixing bracket using the tool provided then pull clear and from the location studs.
- Carefully lift the glass panel from within the bottom location slot.
- Remove the log fuel bed shapes and bark shapes.
- Lift out the air tray assembly from the location points within the shelf.

The pilot is located on the right hand side of the appliance, any debris in or around the aeration hole should be removed using the nozzle of a vacuum cleaner. It is advisable not to blow the debris into the hole as this may cause more of a restriction and not rectify the problem.

Note: - Take care when cleaning in this area so as not to damage the pilot assembly.

GLASS CLEANING

From time to time it will be necessary to clean the glass panel of your 600 FL. We recommend you use a Ceramic hob cleaner these are available for all leading super markets: - i.e. **ASDA, TESCO, SAINSBURY'S** Etc.

Brands of hob cleaning we have tested and found suitable are - **HOB BRITE & VITRO CLEAN.**

- Ensure the fire has been turned OFF for at least four hours to ensure it is cool.
- Remove the glass panel as described below.
- Lay the glass panel down on a flat working surface on top of an old opened newspaper with the side to be cleaned uppermost.
- Follow the instructions on the Hob Cleaner Bottle.
- On stubborn stains (where the appliance has been used for a long period without glass panel being cleaned), use a new Brillo Pad well wetted with the Hob cleaner applied directly to it.
- Ensure all the residues of the cleaner are removed with a damp cloth and the glass panel is completely dry before fitting to the appliance.

Important:- The appliance must not be used if the glass panel is missing or damaged.

Note: - The glass may discolour quickly when first installed, and it should be cleaned. This is due to the burning off process of the refractory fuel bed shapes.

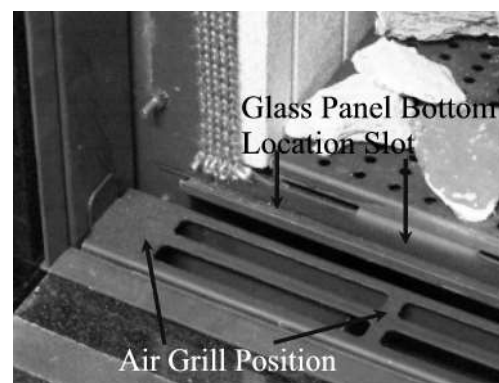
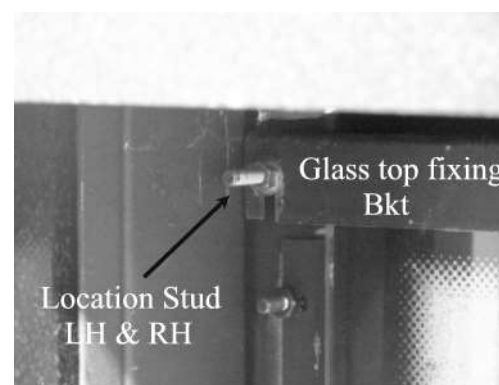

600 FL Users Instructions

SECTION THREE Cleaning Continued

REMOVING GLASS PANEL

- Remove the two side covers LH and RH which are held on with magnets.
- Undo the two M4 nuts retaining the glass fixing bracket using the tool provided then pull clear from location studs.
- Carefully lift the glass panel from within the bottom location slot.

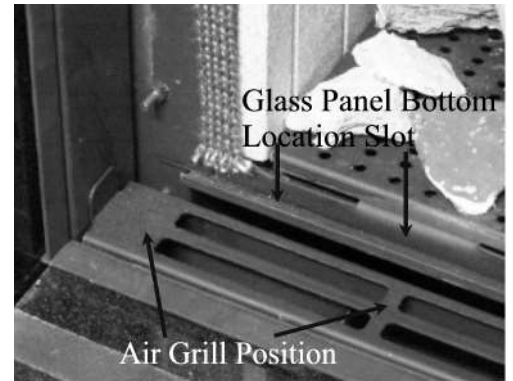
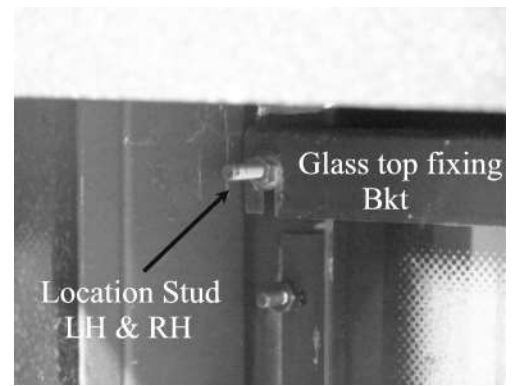

SECTION FOUR Fuel Bed Cleaning and Layout

- Before you clean any part of the appliance ensures that the appliance is turned off and cold.
- Use only the fuel bed components provided and no additional parts must added.
- Incorrect positioning of the fuel bed components could result in the staining of the glass panel.

Important: - Refer to the 'Health & Safety Notice located on page 3 of this booklet before cleaning or replacing any refractory material.

- The fuel bed components are delicate and they should be handled with great care.
- The moulded shapes may be removed for cleaning. They can be brushed very gently with a soft brush to remove dust or any deposits.
- A vacuum cleaner may only be used after the loose components and moulded shapes have been removed.

CARE SHOULD BE TAKEN TO AVOID CONTACT WITH THE REFRACTORY LINING THIS IS A DELICATE SURFACE AND SHOULD **NOT** BE WIPED OR RUBBED.

It is important that all the fuel bed moulded shapes are positioned as shown in these instructions.

Fitting the fire liners

Once the firebox is secured into position fit either the vermiculite or brick back liners supplied.

Position the 2- piece rear liner behind the 3 lugs located at the bottom rear of the firebox. The vermiculite liner has a vertical joint and the brick back has a horizontal joint. Ensure these are aligned centrally.

Rest the side liner on the location bracket on either left or right hand side of fire box. Push up and into position. The vermiculite liners are reversible but the brick back liners will only fit one way.

Once liners are in place fit the air-tray and lay fuel bed.

* *Please note:* When fitting the optional black glass liners, removal of the burner tray may be required to give adequate clearance.

600 FL Users Instructions

SECTION FOUR Fuel Bed Cleaning and Layout

- Place air tray within burner shelf assembly and cover the burner plate with a thin layer of vermiculite and Para glow provided. Pull Para glow apart to lengths required. ENSURE THE PARA GLOW DOESN'T TOUCH THE ELECTRODE



- Place the two log shapes as shown



- Place the two log shapes as shown.



SECTION FOUR Fuel Bed Cleaning and Layout Continued

- Place the two log shapes as shown.



- Place the two log shapes as shown.



- Place the two log shapes as shown.



600 FL Users Instructions

SECTION FIVE General Points

Like all appliances incorporating an aerated burner a low frequency noise may be heard, particularly on the low setting, this is quite normal and does not affect the operation of the appliance.

It is advised that a competent person service the 600 FL fire annually. The fire is more likely to provide trouble-free operation.

Dulling and slight discoloration inside the firebox will occur adding to the realism of the appliance. This is normal.

It is important that: -

The chimney or flue is checked annually to ensure clearance of combustion products. This can be inspected by removing the inner firebox and removal of the inspection covers located on the back and top of the outer firebox. This can be obtained by doing the following.

- Remove the two side covers LH and RH which are held with magnets.
- Undo the four M4 nuts retaining the glass fixing bracket using the tool provided then pull clear and remove from location studs.
- Carefully lift the glass panel from within the bottom retaining slot.
- Remove the log fuel bed shapes.
- Lift out the air tray assembly from the location points within the shelf.
- Pull out the air grill and disconnect the battery holder from the lead and remove.
- Remove the two screws retaining the gas connection cover from within the burner shelf and remove cover. Shut down restrictor elbow and disconnect the 8mm inlet nut.
- Undo the three fixing screws from the burner tray and lift out burner tray assembly taking care not to damage the liners.
- Remove the six M4 nuts from the front face of the inner firebox.
- Taking care not to damage the top liner remove the three fixing screws from the top of the inner firebox.
- Carefully pull the inner firebox forward to clear the outer firebox assembly.
- Remove the inspection plates located within the outer firebox taking care not to damage the sealing gaskets.
- After inspection for clearance is completed reassemble in reverse order.

The only user removable parts are: -

- Refractory Fire bed Components
- Side covers and air grill.
- Glass panel top fixing bracket.
- Glass panel.

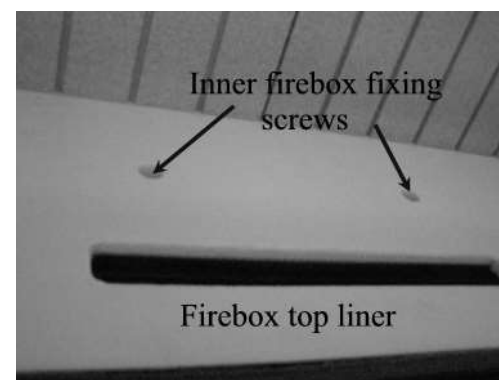
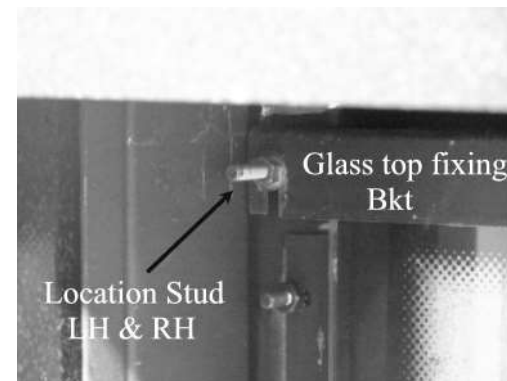

SECTION SIX Appliance Data

NATURAL GAS

Gas Type:.....CATEGORY I 2 H
Gas Pressure:.....20 mbar +/- 1.0mbar
Pressure Test Point Location:.....Gas inlet elbow
Gas Input:.....5.5 kW Gross (Max.)
.....2.4 kW Gross (Min.)
Injectors:.....Mk 360
Oxy pilot:.....9102 N.G.

PROPANE GAS

CATEGORY 1 3 P
37 mbar +/- 1.0mbar
5.0kW Gross (Max.)
2.4kW Gross (Max.)
Mk 116
9264 L.P.G.

NOx Classification 5
Gas Connection:.....8mm compression: semi-rigid or rigid
Data Badge Location:.....Located on the right hand side of the appliance on the base
Battery.....Remote handset size 3 x 1.5v AAA,
Appliance 6 x 1.5V C high power alkaline.

Appliance Dimension

NOTE: The efficiency of this appliance has been measured as specified in BS7977-1 2009+A1:2013 and the result is 74.40 %. The gross calorific value of the fuel has been used for this efficiency calculation. Gastec have certified the test data from which it has been calculated. The efficiency value may be used in the UK Government's Standard Assessment Procedure (SAP) for energy rating of dwellings. **Please note:** Within the appliance packaging will be a outlet restrictor, this is there to achieve the maximum efficiency. This, however, may not be fitted due to the flue underperforming.

When unpacking the appliance please check the following items are included:

Fuel Bed: Air Tray Fireplace Frame Assembly.
Owners Manual Vermiculite

SECTION SEVEN Regulations and Warnings

- This appliance must only be installed in Great Britain or Ireland.
- The appliance is suitable for use on natural gas only.
- **GB (Great Britain)** This fire does not normally require purpose built ventilation.
- **IE (Ireland)** Permanent ventilation must comply with the current edition of IS813.
- **In GB, (Great Britain)**
It is the law that all gas appliances must be installed by a competent person; i.e. a GAS SAFE registered installer, in accordance with the Current Gas Safety (Installation And Use) Regulations (as amended), all relevant parts of the local and national building regulations and all relevant recommendations of the following British Standards. Failure to do so could lead to prosecution.
The following are relevant codes of practice and British Standards: -
B.S. 5871
B.S. 5440 PART 1 & PART 2
B.S. 6891
This appliance must be installed to current versions of the above standards and include any relevant amendments to:-
The Building Regulations Issued By The Department Of The Environment.
The Building Standards (Scotland) (Consolidated) Regulations Issued By The Scottish Development Office.
- **IN IE, (Ireland)**
The appliance must be installed by a competent person and installed in accordance with the current edition of I.S.813 Domestic Gas Installation, the current building regulations, and the current ETCI rules for electrical installation, if appropriate.
- Prior to the installation ensure that the local distribution conditions (identification of type of gas and pressure) and adjustment of the appliance are compatible. (G20 @ 20mbar or G21 @ 37mbar)

WARNINGS

- The glass front of the fire act as a dress guard, conforming to BS 1945 (1971) and satisfies the heating appliance regulations (1991) However, a guard conforming to BS6539 (1984) must be used to protect young children, the elderly or infirm.
- **This appliance incorporates a safety device in the form of an Oxygen depletion system. IT MUST NOT BE ADJUSTED OR PUT OUT OF OPERATION! THIS IS A NON-SERVICABLE ITEM AND MUST BE EXCHANGED AS A COMPLETE ASSEMBLY; USING ONLY THE ORIGINAL MANUFACTURER'S PART.**
- A suitable proprietary fire surround with a 150°C minimum rating is required.
- During initial firing, an odour may be evident. This is the starch binder used during the manufacture of the fibre components of the fire, and there are **no harmful** effects produced.
- Care must be taken to prevent any damage being caused to surrounding soft furnishing or decoration; e.g. many embossed vinyl wall coverings may become discoloured if placed too close to the appliance.

SECTION EIGHT Siting the Appliance**• CLASS ONE**

That is a conventional brick or stone chimney as used for a solid fuel appliance with an effective cross-sectional dimension of 225 x 225 mm (9" x 9") or a lined flue with a minimum diameter of 125mm (5"). The chimney must have a minimum effective height of at least 3 metres. Any permanent flue restriction or variable dampers are to be removed or locked fully open. The chimney should be swept prior to installation if it has previously been used with solid fuel. This is not necessary if the flue has previously been used with a gas appliance or if it is a new installation.

Note: A brick or stone chimney with a 125 mm (5 ins) minimum diameter flue liner conforming to BS 715 may be used. Provided a suitable sealing plate is fitted to the base of the liner and the appliance does not restrict the opening into the liner. Ensure a smooth lead into the flue way and no combustible materials are used. A void of 50mm must be maintained from the top of the firebox to gather into flue.

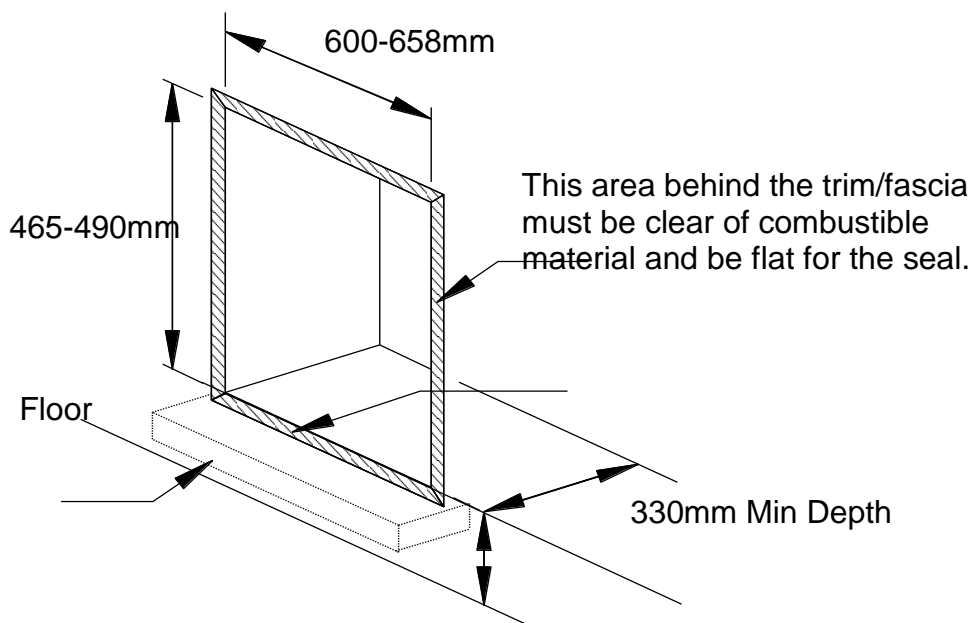
PREPARING THE OPENING FOR STANDARD INSTALLATION

The front face and the base of the fire opening must be flat to ensure that a good seal is formed between the rear and base of the appliance and the chimney to avoid any reduction of natural draught.

*** Please note: It is important to ensure the bottom of the firebox is completely sealed to reduce the risk of excess sooting resulting from incomplete combustion.**

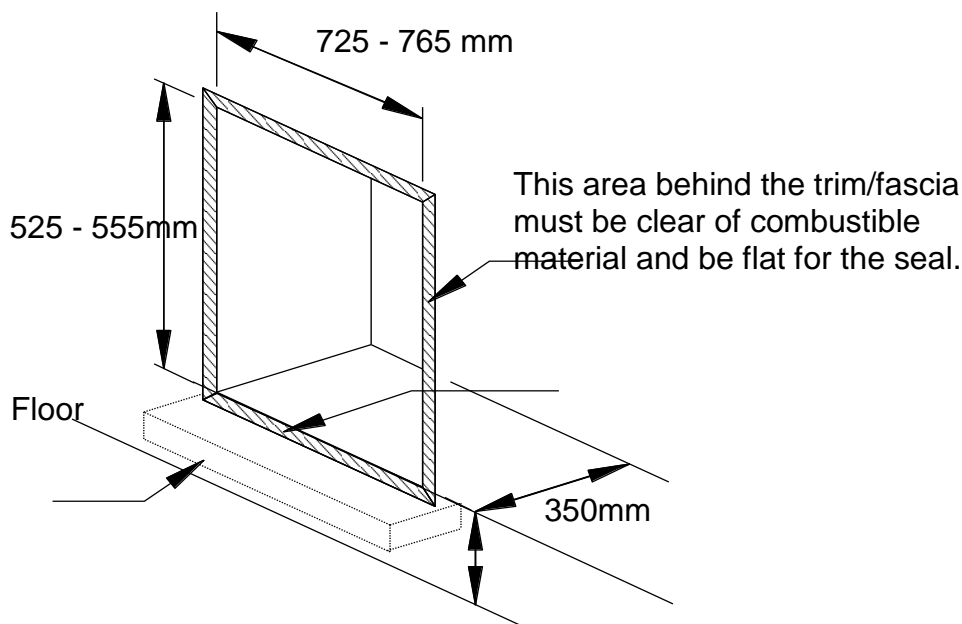
SECTION EIGHT Siting the Appliance**PREPARING THE OPENING FOR INSTALLATION WITH MARBLE SLIPS**

The front face and the base of the fire opening must be flat to ensure that a good seal is formed between the rear and base of the appliance and the chimney to avoid any reduction of natural draught. * **Please note: It is important to ensure the bottom of the firebox is completely sealed to reduce the risk of excess sooting resulting from incomplete combustion.**

Locate the slip mounting frame (supplied as an optional extra) by hooking onto the existing studs on the firebox with the fireplace frame already located. It is the responsibility of the installer to ensure the slips are secured using a reliable bonding material.

Class one Installation with a flexible liner using optional gather hood (Part No A-0293)

- Route the flexible liner within the brick built flue as of the requirements stipulated by the liner manufacture.
- Attach the gather hood to the liner using a suitable fixing at a height that clears the out fire box assembly.
- Remove the inner box and top inspection cover as described in section five general points.
- With the out fire box in place, attach the gather hood to the fire box using the four fixing screws provided within the kit.
- Re- assemble in reverse order.

Clearance to Shelf

Minimum clearance from hearth or base of opening to underside of combustible shelf should be 800mm provided the shelf depth is 75mm (3"). This gives a minimum clearance above the appliance of 140mm. For a shelf of 150mm (6") the minimum height above the hearth or base of opening must be 880mm. This will give a minimum clearance above the appliance of 220mm.

Clearance to Sides of Fire

Minimum width between vertical sides of combustible surround should not be less than 875 mm provided fire is central to the surround and sides do not project more than 150 mm. When vertical side forward projection is increased by 12.5 mm add 50 mm to inside width of surround.

SECTION EIGHT Siting the Appliance Continued

CHECKING THE FLUE AND FIRE OPENING

- Check that the chimney conforms to the required specifications as previously stated. Examine the condition and carry out any remedial work including removing any debris from the base.
- If the flue has been used for solid fuel it should be swept prior to the installation
- Prior to installing the appliance a smoke test (using a smoke bomb) should be carried out to check that satisfactory smoke clearance has been established.

If all the smoke is not drawn into the flue, pre-heat the flue with a blowtorch or similar and re-check. If there is any uncertainty examine for the cause and, if necessary, seek expert advice.

No combustible material should be fitted inside the fireplace opening.

- When installing this appliance against a dry lined (plasterboard) wall ensure that any void between the plasterboard and the wall is sealed with a suitable non-combustible material (i.e. plaster or mortar).

SECTION NINE To Install the Appliance

GAS SUPPLY ROUTING

Use rigid or semi – rigid tube to connect the supply. Determine the gas supply pipe route to the appliance before installing the fire.

Fixing Firebox Assembly

- Slide the firebox into the fireplace open guiding the gas supply pipe through the hole at the rear LH bottom of the firebox.
- Retain the Firebox using wall plugs and screw using the four holes within the firebox flange.
- Refit the grommet over the pipe and seal around the inlet hole.
- The Fireplace frame can now be located onto the firebox assembly and retained using the six off M4 nuts provided.
- Remove the gas connection cover located within the burner shelf left hand side and connect to the restrictor elbow provided.

Note: - The isolation valve must be fitted at a angle to allow access to the restrictor plug plus gas pressure test nipple.

- At this point the fireplace or false chimney breast front will need to be constructed.
- Connect battery pack as described in section 2. (Operating the appliance). Locate the battery pack in the holder positioned within the fireplace frame.
- Now check that a signal is being received by pointing the remote control hand set in the direction of the appliance and press ON / OFF Key for at least 2 seconds. On release a bleep should be heard and the ignition process will start.

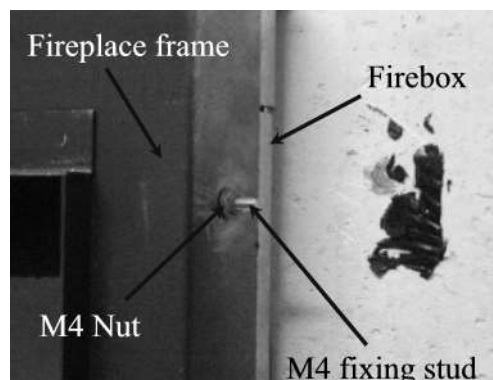
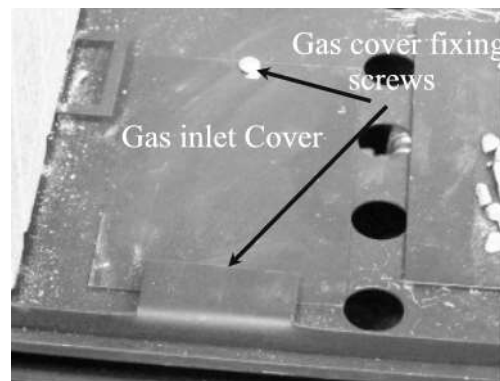

SECTION NINE To Install the Appliance Continued CHECKING GAS SOUNDNESS AND RUNNING PRESSURE.

- Turn on the gas supply to the appliance and check for soundness in accordance with current codes of practice.
- Turn off the gas supply at the external Isolation valve.
- Remove the pressure test point screw from the inlet elbow and connect the pressure gauge.
- Turn on the gas to the appliance at the Isolation valve.
- Light the appliance as described in section 2.
- Check the inlet pressure is 20mbar. +/- 1.0 or 37mbar +/- 1.0
- Turn off gas supply, at the isolation valve. Disconnect the pressure gauge and replace the pressure test point screw.
- Turn on the supply to the appliance and check the pressure test point for soundness with detection fluid.
- Refit the gas connection cover.
- Fit the air tray within the location with the burner shelf.

Construction of a false chimney breast front.

- Using 50mm K.D Sawn stud-work will provide the required rebate.
- The vertical sides of the stud-work should not be less than 502mm from the centre of the firebox. The horizontal stud-work should not be less than 764mm from the base of the firebox. This will ensure 50mm minimum clearance from the sides and 110mm clearance from the top of the firebox is maintained.
- An insulation material (20mm "Super lux" or equivalent) should be attached to the underside face of the horizontal stud-work directly above the firebox assembly.
- Line the opening with 12mm thick non-combustible material.

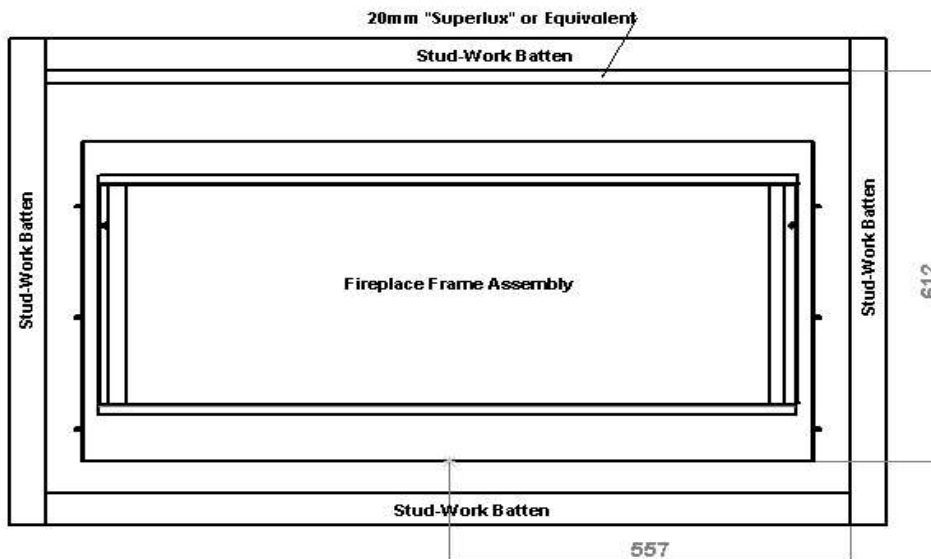

FIT LINERS (See Page 9)

LAY FUEL BED

Important: -

Refer to the 'Heath & Safety Notice located on page 3 of this booklet before laying or replacing any refractory material. In the event of replacing fuel bed components please use only the specified number of components as illustrated. Only use fuel bed component provided for this appliance. In the interest of safety and efficiency of your appliance when replacing the fuel bed it is essential that the existing fuel bed be removed and the new components are replaced correctly as a complete set.

Lay fuel bed as described under Users Section.

Warning:

It is important that the fuel bed components are positioned as shown in these instructions. If the fuel bed components are not positioned correctly this may result in damage to the glass.

SECTION TEN Checking Operation of Fire REFIT GLASS PANEL AND FIREPLACE FRAME COVERS

- Locate the glass panel within the bottom glass retaining slot and push back against the firebox seals.
- Locate the glass fixing bracket over the top edge of the glass panel and slide over the two M4 studs.
- Using the two M4 nuts provided tighten the glass fixing bracket.
- Insert the air grill within the bottom space of the fireplace frame.
- Finally insert the LH and RH side covers between the sides of the glass panel and fireplace frame.

CHECKING FOR COMBUSTION PRODUCTS CLEARANCE

IMPORTANT:-The smoke test must be carried out with the fire starting from cold.

- Light the fire and leave at maximum input.
- Close all the doors and windows.
- After five minutes fit the smoke match in a holder and position as illustrated with the head of the match just inside the test opening.
- Run the match along the top edge **All smoke** must be drawn into the test opening if the clearance is satisfactory.
- If spillage occurs wait a further five minutes and repeat the test.
- Repeat the test with doors open and with any extractor fans in other rooms in operation.
- If spillage is detected the cause must be discovered and the fault corrected, if the fault cannot be corrected, disconnect the fire from the gas supply and seek expert advice. Spillage can be caused by a restriction in the flue system, down draught or insufficient ventilation into the room where the fire is installed.

ADVISE CUSTOMER THAT:

- The glass front of this fire acts as a dress guard, conforming to BS 1945 (1997) and satisfies the heating appliance regulations (1991) however; a fireguard conforming to BS6539 (1997) must be used to protect young children, the elderly, or infirm.
- The curing effect of heating the logs and other refractory components will cause an initial odour. This is due to the starch used in the manufacturing process and is non-toxic.
- Any debris should be cleaned from the appliance. A vacuum cleaner can be used but only after all the loose logs have been removed.
- The appliance should be serviced annually by a competent person in accordance with these instructions and the appliance checked for spillage in accordance with the method detailed in these instructions.
- Demonstrate changing the batteries.
- Demonstrate the lighting and extinguishing procedures to the user and the removal and refitting of the glass panel for cleaning. Refer to the user section of this booklet.
- If ventilation is fitted for any reason it must be checked regularly to ensure freedom from obstructions.
- **Hand these instructions over to the user along with the spare batteries and glass removal tool.**

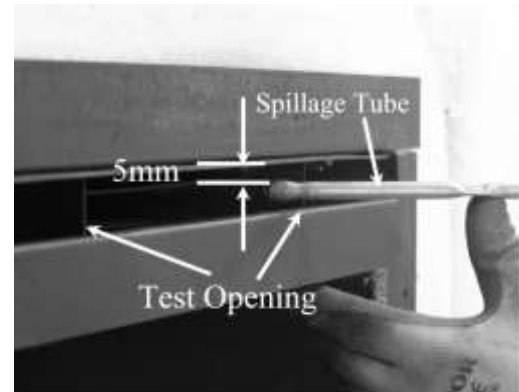
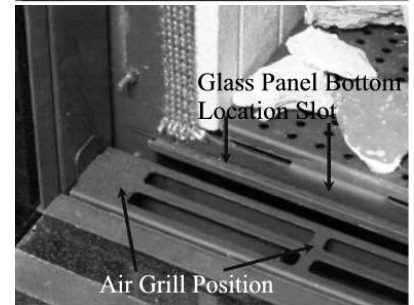

SECTION ELEVEN Maintenance

GENERAL

- Servicing should be carried out annually by a competent person such as a Gas safe-registered person in accordance with the relevant regulations, to ensure the safe and correct operation of the appliance.
- Before commencing any service or replacement of parts, turn off the gas supply to the fire. After servicing check for gas soundness.
- When ordering spare parts please quote appliance name and serial number, these can be found on the data badge, which is located on the left hand side of the appliance behind the trim or fascia.
- At least once a years check for debris in the catchment area behind the fire and in the flue way.
- If soot has accumulated checks to establish cause rectify and clean flue or chimney accordingly.

PILOT LINTING

Check pilot aeration holes for linting, use a vacuum cleaner nozzle taking care not to damage the pilot head.

TO REMOVE THE BURNER TRAY

- Remove RH and LH side covers undo glass fixing.
- Remove glass panel.
- Remove the loose fuel bed components.
- Disconnect battery leads and remove appliance battery pack.
- Remove gas supply cover.
- Disconnect fire at inlet elbow and Undo the three burner tray fixing screws. Pull carefully forward and remove.
- For normal servicing the tray can be cleaned using a vacuum cleaner.
- Whilst the tray is removed vacuum the firebox if necessary.

REPLACEMENT OF GAS CONTROL

- Follow the burner tray removal sequence.
- Disconnect the thermocouple from the rear of the gas valve.
- Undo the three compression nuts securing the pipes to the gas valve and remove the two screws fixing the valve to the bracket.
- Clean, service or replace gas valve.
- Re-assemble in the reverse order.
- Turn on the gas supply, check for soundness and re-commission appliance.

REPLACEMENT OF INJECTOR

- Follow the burner tray removal sequence.
- Undo the compression nut on the supply pipe.
- Unscrew the locking nut holding the injector on the chassis.
- Clean or replace the injector.

NOTE: -Do not use a wire or a drill to clean out holes. Refer to the appliance data section for details.

- Re-assemble in reverse order.

SECTION ELEVEN Maintenance Continued

REPLACEMENT OF OXY-PILOT ASSEMBLY

NOTE: If the pilot assembly is replaced it must be replaced by an identical unit from the same manufacturer and replaced as a complete unit.

- Follow the burner tray removal sequence.
- Undo the compression nut on the supply pipe at the pilot.
- Carefully pull off the ignition lead.
- Disconnect the thermocouple at the end of the main control valve.
- Remove the cross headed nut holding the pilot to the chassis
- Carefully remove the pilot shield & oxy-pilot.
- Re-assemble in reverse order.

REPLACEMENT OF CONTROL UNIT (EDB)

- Follow the burner tray removal sequence.
- Disconnect leads from control unit and remove 2 bolts.
- Re-assemble in the reverse order.

Turn on the gas supply, check for gas soundness and re-commission appliance.

SECTION TWELVENE Wiring Diagram

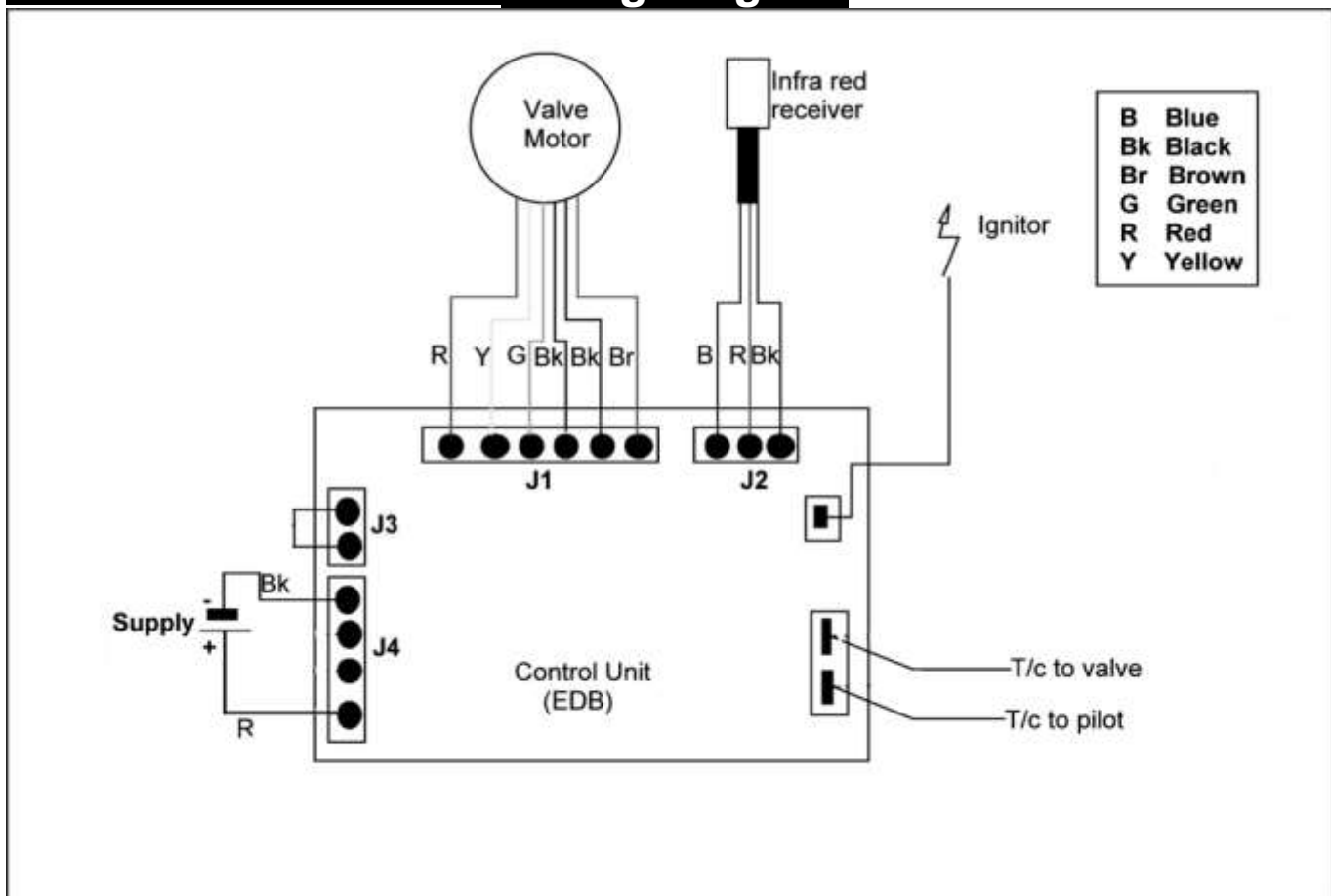

600 FL

WARRANTY

THIS IS YOUR EXTENDED FIVE YEAR PARTS

PLEASE READ IT CAREFULLY AND ENSURE YOUR INSTALLER HAS FILLED IN THE FIRST PORTION, KEEP IT IN A SAFE PLACE SO THAT IT IS AVAILABLE WHEN YOUR Gas Safe ENGINEER CARRIES OUT THE ANNUAL SERVICE.

THIS IN NO WAY REDUCES YOUR STATUTORY RIGHTS

THE WARRANTY COMMENCES FROM THE DATE OF PURCHASE YOU MUST RETAIN YOUR RECEIPT OR INVOICE AS PROOF OF PURCHASE.

THIS EXTENDED WARRANTY SPECIFICALLY EXCLUDES SOFT REFRACTORY COMPONENTS, THE BULB AND ANY BATTERIES.

Terms and Conditions

1. The appliance must be installed by a Gas Safe registered person.
2. The appliance must be used in accordance with the users instructions.
3. The appliance must be serviced annually by a Gas Safe registered person.
4. The service log must be correctly filled out and the record of annual services must be up to date and supported by receipts in each case.
5. This warranty is not transferable and relates to the original installation only.
6. The Registration Form must be correctly filled out and returned.
7. The appliance has not been subjected to misuse or accident or been modified or repaired by any person other than the authorised employee or authorised representative of Charlton and Jenrick Ltd.
8. The registration form must be returned within 3 months of purchase.

INFINITY HELPDESK NUMBER 0845 5195991

Important

For future reference we suggest you record the following details here, and keep the receipt as proof of purchase. This information may be asked for when you contact the helpdesk.

Model: **600 FL** **Serial No.**

--	--	--	--	--	--	--	--	--	--

This information can be found on the label attached to the packaging and on the data badge, which is located on the appliance flange, top right behind trim.

Retailer Name:

Address:

Date of Purchase:

--	--	--	--	--	--	--

Service Log

The following information must be complete and supported by receipts as part of the conditions of the extended three year parts warranty and the appliance must be registered by completing and returning the registration document (last page of this booklet) to Paragon Fires.

Date of First annual service:

Engineer Name _____

Gas Safe Registration No.

Date of Second annual service:

Engineer Name _____

Gas Safe Registration No.

Date of Third annual service:

Engineer Name _____

Gas Safe Registration No.

Date of Fourth annual service:

Engineer Name _____

Gas Safe Registration No.

We may introduce modifications to products from time to time, and consequently the details given in this booklet are subject to alteration without notice.

Infinity
Charlton & Jenrick LTD
Telford
Shropshire
TF3 3AR
Telephone 0845 5195991

PLEASE REGISTER YOUR 12 MONTH WARRANTY WITH US TODAY

Simply detach this sheet from this booklet, complete and return it in a stamped addressed envelope to:

Infinity
Charlton and Jenrick Ltd
UNIT D
STAFFORD PARK 2
TELFORD
SHROPSHIRE
TF3 3AR

YOUR DETAILS

Name _____

Address _____

Post Code

TELEPHONE No.

PRODUCT DETAILS

Model: : **600 FL** **Serial No.**

Date of Purchase

This information can be found on the label attached to the packaging and on the data badge, which is located on the appliance flange, top right behind trim.

WHERE DID YOU PURCHASE THIS PRODUCT

Name _____

Address _____

Post Code

TELEPHONE No.

Infinity 600 FL

Product ID Label	A-0323	Serial No Prefix	MZ (Ng)	
	A-0340		MW(Lpg)	
Burner Tray / Box Assembly				
Complete Log Fuel Bed (5997)				
Grommet (1092)				
Top Liner Fitted				
7mm Nut Spinner				
Restrictor Plate				
Side Covers (5995)				
Infill Cover (5988)				
Glass Panel				
Air Tray (5994)				
Silicone Sealing Strip (4818)				
'C' Cell Battery (12)				
Remote Control Hand Set				
Handset Holder (5910)				
Battery Holder				
AAA Battery (3)				
Owners Book				
Data Badge				
Warning Label (1409)				
ID Label & Packing Labels				
Serial Number				
Inspector				